

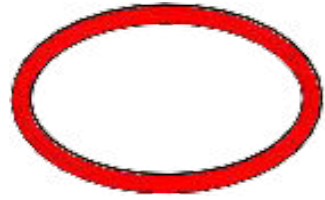

3x 6028041



1x 4544143



2x 4629921



4x 4141300

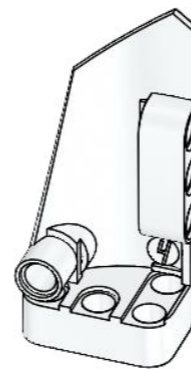

3x 4547581

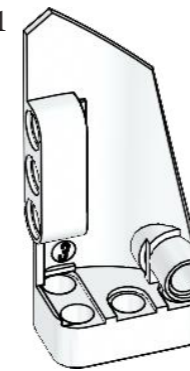

3x 4547582



5x 4255563

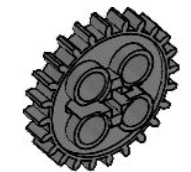

2x 4514558



4x 4177430



2x 4177431

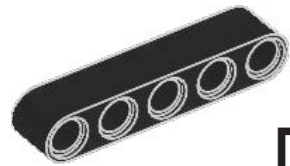

10x 4142135

5

12x 4111998

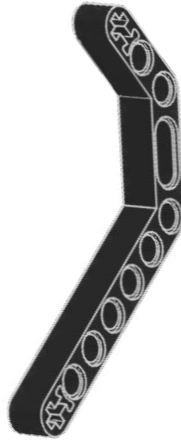

6x 4495935

7

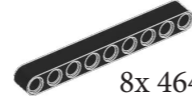

8x 4645732

9

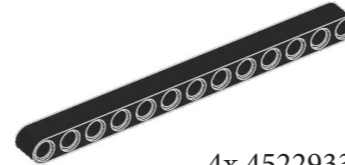

4x 4522933

13

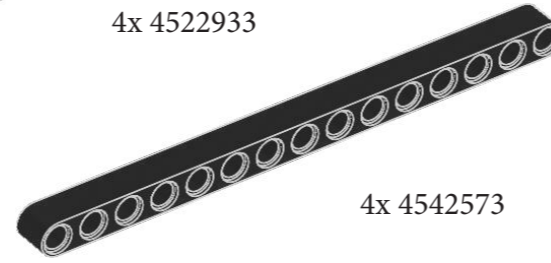

4x 4542573

15



3x 4558797



3x 4558802



8x 4120017

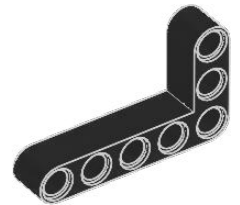

6x 4142823



12x 4142822

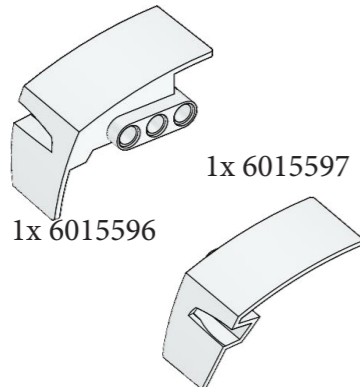

1x 6015597

1x 6015596



1x 4189131



1

6x 4234429

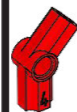

4x 4189936



3x 4513174



6x 4185661



4x 4173975



2x 4128594

14x 4175442



8x 4188298



12x 4142865



9x 4227155



10x 4140806



6x 4560175



2x 4211553



2x 4526985



2x 4630114



1x 4502595



1x 4211566



2x 4246901



2x 4143187



4x 4248204



4x 4211758



1x 4558692



12x 4225033

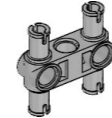

3x 4494222

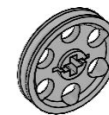

2x 4211510



6x 4499858

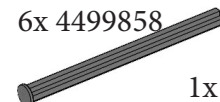

1x 4535768

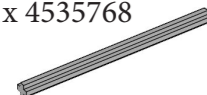

2x 4211805

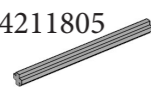

9x 370626



9

7

6

4x 4562805

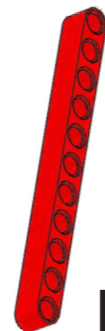

11

4x 4128593



12x 4140327

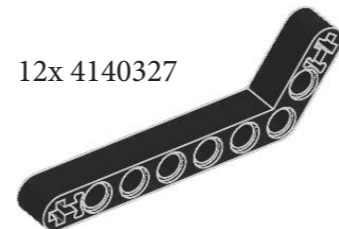

6x 4657296



2x 4538007



4x 4211888



4x 6013936



4x 4211807



6x 4211375



6x 4184169



9x 4211639

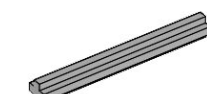

22x 4211815

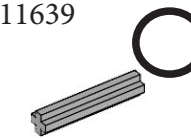

5

95x 4121715



4x 4656205



4x 4173941

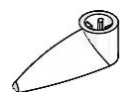

10x 6006140



28x 4206482



11x 4239601



38x 4514553



2x 4508553



4x 4560177

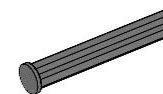

4

4x 4514554

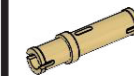

3x 4666999

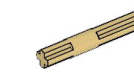

1x 6031962



1x 4565452



4x 6031821

